

## GRP storage cabinet: DMO-33

Dräger Marine & Offshore cabinets are designed for tough offshore conditions. Manufactured from durable GRP material, these cabinets are rated to IP56, certified by Lloyds. All cabinets are manufactured with stainless steel locks and hinges. The cabinets can be configured to suit different storage requirements.



### Features

#### Room to store

- Eyewash bottles
- Safety torches
- Escape masks
- Descent units (donut type)

#### Options

- Shelf
- Ventilation
- Flame retardant version
- Heaters (conventional / ATEX approved)
- Lettering

### TECHNICAL SPECIFICATIONS

Dimensions	580 x 300 x 595 mm (WxDxH)
Aperture dimensions	439 x 300 x 442 mm (WxDxH)
Angle of door opening	90°
Weight	11 kgs
Material	GRP
Colour	Safety Green RAL 6002 Firefighting Red RAL 3000 Safety Orange RAL 2009 Lifesaving White RAL 9010
IP rating	IP56
Door catch	Nylon
Door handle	SS 316
Hinges	SS 316
Seal	EPDM
Reinforcement	Core material
Lettering	White
Approvals	IP56 BS EN 60529:1992 Lloyds

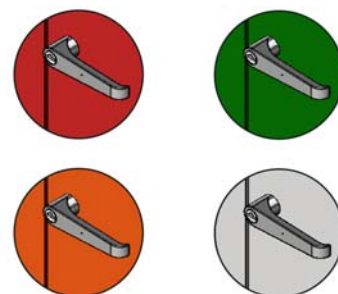

**GRP storage cabinet: DMO-33**  
IP56 rated and Lloyds certified

Front View

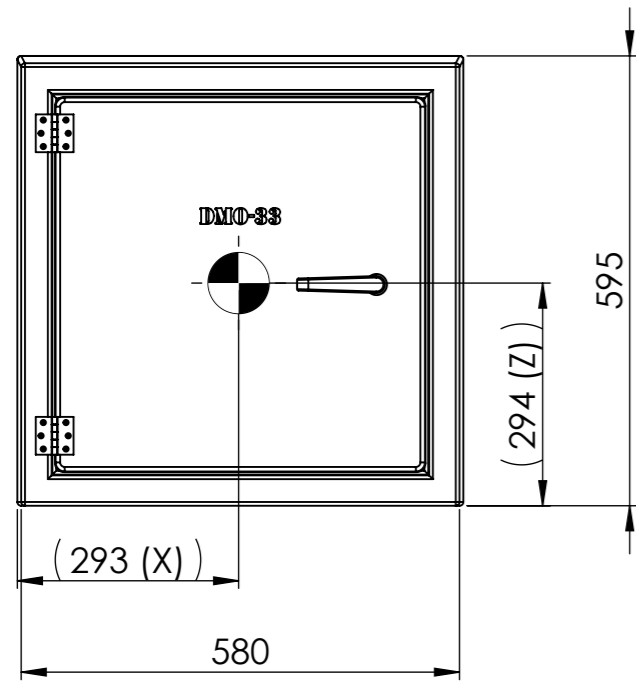

Side View

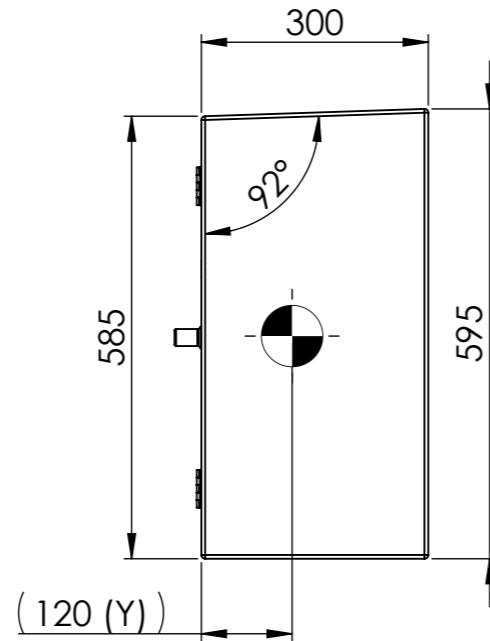

ISO View

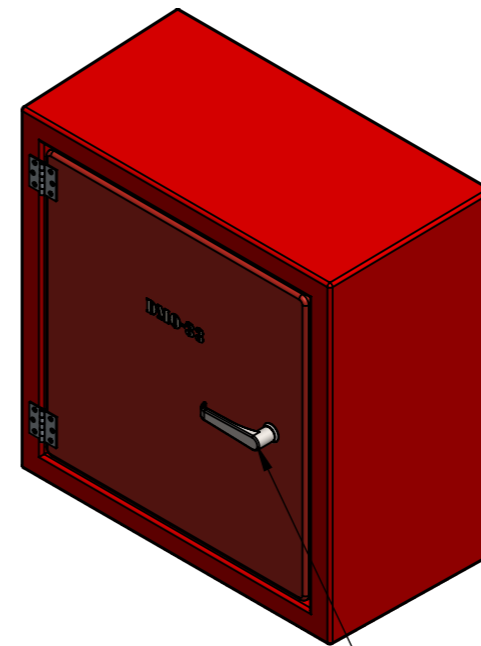

Rear View

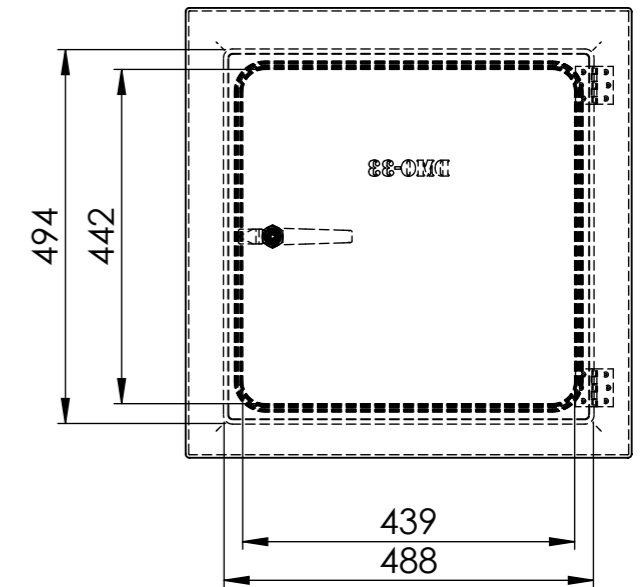

Top View

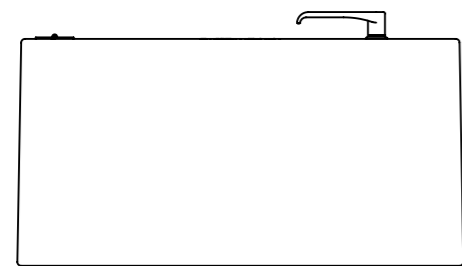
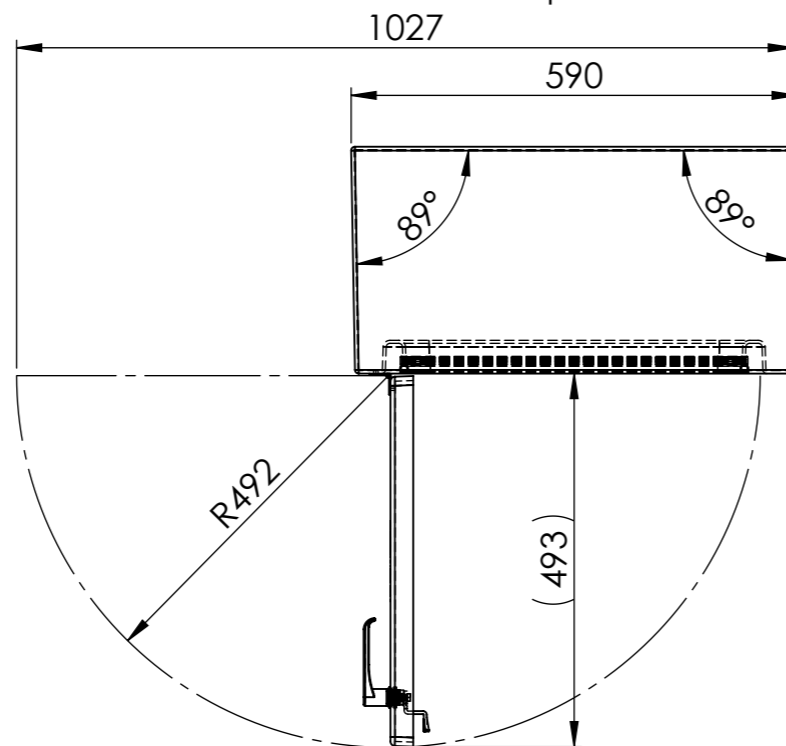

Footprint

Colour	RALxxxx
Material	3-4mm GRP
Lock and hinges	Stainless steel
Weight cabinet	xxKg
Weight cabinet incl. content	Invulbaar
C.O.G.	X 293 / Y 120 / Z 294 from datum
Text on cabinet	Invulbaar
Tag on cabinet	Invulbaar
Mounting instructions	Invulbaar

Storage for	
-------------	--

<b>Dräger</b>	Date	Name	SW Filename
	Drawn 13-2-2023	B.S.	DMO_33_00
Dräger Nederland B.V. Marine & Offshore Beurtschipperstraat 1 3194 DK, Hoogvliet-RT the Netherlands		Comments: +31 10 2952772	

Scale: 1:10	Projection	Description:	Art.Nr:	Sheet	Format:
Units: mm		DMO Cabinet 33	DMO_33	1 of 5	A3