

## GRP veiligheidskast: DMO-33

Dräger Marine & Offshore kasten zijn ontworpen voor zware offshore-omstandigheden. Vervaardigd van duurzaam kunststof materiaal, zijn deze kasten geschikt tot IP56 zoals gecertificeerd door Lloyds. Alle kasten zijn vervaardigd met RVS sloten en scharnieren. De kasten kunnen worden aangepast om aan verschillende eisen te voldoen.



### Eigenschappen

#### Opbergruimte

- Oogspoelflessen
- Veiligheidsfakkels
- Vluchtmaskers
- Uitschuifbare trap (donut type)

#### Opties

- Plank
- Ventilatie
- Vlamvertragende versie
- Verwarming (conventioneel / ATEX goedgekeurd)
- Belettering

### TECHNISCHE SPECIFICATIES

Dimensions	580 x 300 x 595 mm (BxDxH)
Afmetingen deuropening	439 x 300 x 442 mm (BxDxH)
Hoek van deuropening	90°
Gewicht	11 kg
Materiaal	GRP
Kleur	Safety Green RAL 6002 Firefighting Red RAL 3000 Safety Orange RAL 2009 Lifesaving White RAL 9010
IP klasse	IP56
Deurvergrendeling	Nylon
Deurgreep	SS 316
Scharnieren	SS 316
Afwerking	EPDM
Versterking	Basis materiaal
Belettering	Wit
Goedkeuringen	IP56 BS EN 60529:1992 Lloyds

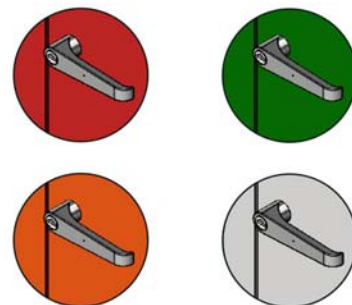

**GRP veiligheidskast: DMO-33**  
IP56 en Lloyds gecertificeerd

Front View

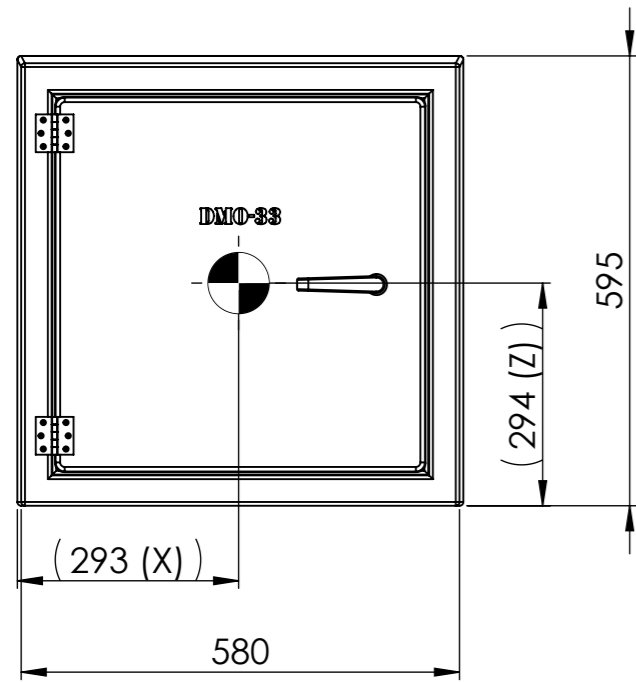

Side View

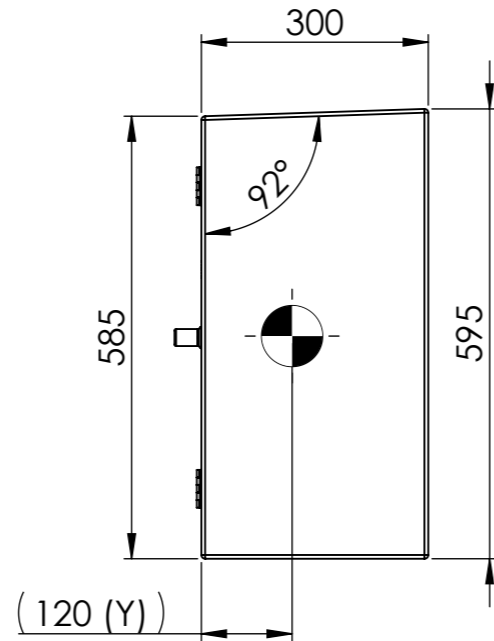

ISO View

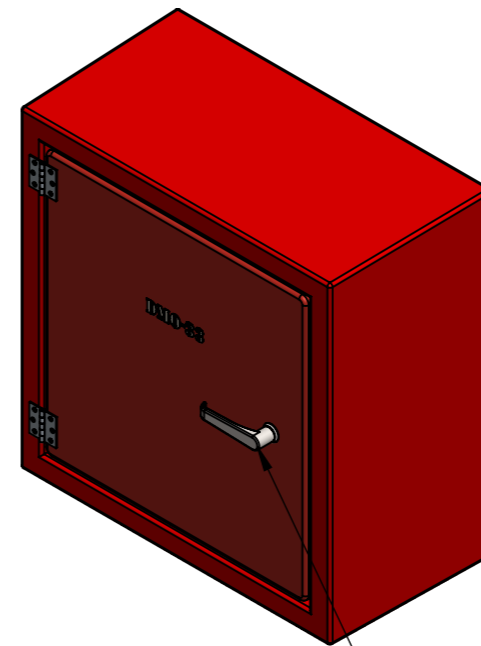

Rear View

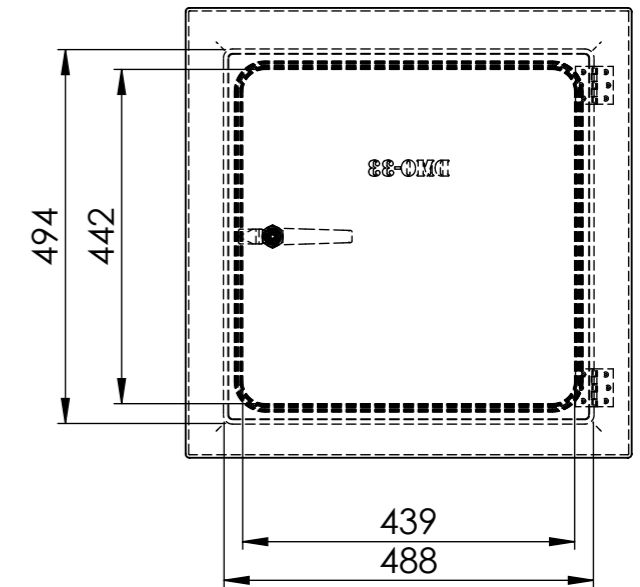

Top View

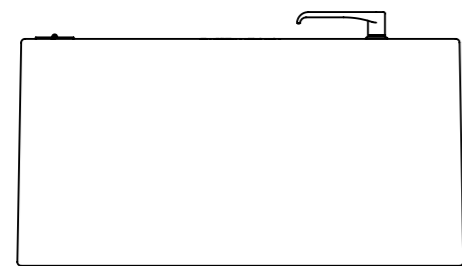
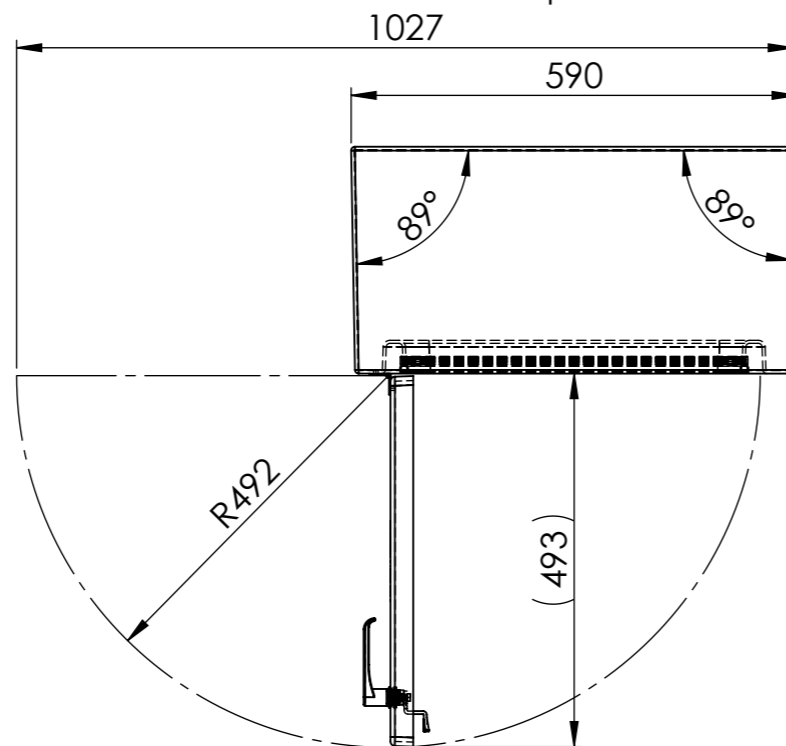

Footprint

Colour	RALxxxx
Material	3-4mm GRP
Lock and hinges	Stainless steel
Weight cabinet	xxKg
Weight cabinet incl. content	Invulbaar
C.O.G.	X 293 / Y 120 / Z 294 from datum
Text on cabinet	Invulbaar
Tag on cabinet	Invulbaar
Mounting instructions	Invulbaar

Storage for	
-------------	--

	Date	Name	SW Filename
<b>Dräger</b>	13-2-2023	B.S.	DMO_33_00
Dräger Nederland B.V. Marine & Offshore Beurtschipperstraat 1 3194 DK, Hoogvliet-RT the Netherlands			Comments: +31 10 2952772

Scale: 1:10	Projection	Description:	Art.Nr:	Sheet	Format:
Units: mm		DMO Cabinet 33	DMO_33	1 of 5	A3